

t h e e s s e n t i a l s c h o i c e

Issue No 4

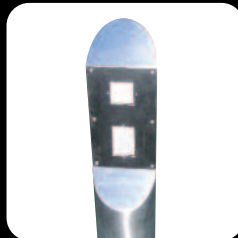

Guide / Barrier Rails

- Flat Bar Profile
 - Tubular Profile
-

Push Pad Activation Switches

- Jamb Style
 - 115mm Square
 - 115mm Round
 - 152mm Square
 - 152mm Round
-

Activation Devices

- Transmitters & Receivers
 - Key Switches
 - Buttons & Pads
 - Bollards
-

Activation and Safety Sensors

- Reglomat
 - Optex
 - BEA
 - Pepperl & Fuchs
 - Hotron - To order only
-

Special Activation Devices

- Touchless
 - Pull Switches
-

Hardware Accessories

- Finger Protection
 - Legend Plates
 - Signs
 - Door Controls
-

Access Controls

- Magnets and Electric Strikes
 - Access Control Systems & Entry Systems
 - Toilet Entry Systems
-

Terms & Conditions

- * Carriage Options

email orders to sales@rtrservices.co.uk

Tel: +44 (0) 870 242 6029 Fax: +44 (0) 870 242 6030

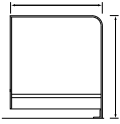
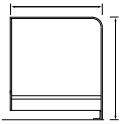
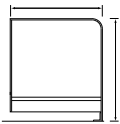
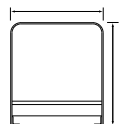
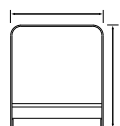
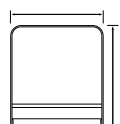

Combination proximity reader and keypad now available.
Models with LCD display due to be launched mid June.
Please call for further information and pricing.

Product	ID Number	Description	Finish	Ref.	Price
	FAB-6002 FAB-6004	Floor to wall mounting. Flat bar profile aluminium guide rail, 900(H) x up to 900mm (W). Unglazed. c/w adjustable mounting foot & fixing pack.	Mill RAL	B	£ 188.00 £ 221.50
	FAB-6002a FAB-6004a	Floor to wall mounting. Flat bar profile aluminium guide rail, 900(H) x up to 900mm (W). Glazed 6mm Clear Safety Glass. c/w adjustable mounting foot & fixing pack.	Mill RAL	B	£ 228.50 £ 257.00
	FAB-6002b FAB-6004b	Floor to wall mounting. Flat bar profile aluminium guide rail, 900(H) x up to 900mm (W). 6mm Solid aluminium panel c/w adjustable mounting foot & fixing pack.	Mill RAL	B	£ 247.00 £ 275.00
	FAB-6012 FAB-6014	Floor to floor mounting. Flat bar profile aluminium guide rail, 900(H) x up to 900mm (W). Unglazed. c/w fixing pack.	Mill RAL	B	£ 188.00 £ 221.50
	FAB-6012a FAB-6014a	Floor to floor mounting. Flat bar profile aluminium guide rail, 900(H) x up to 900mm (W). Glazed 6mm Clear Safety Glass. c/w fixing pack.	Mill RAL	B	£ 228.50 £ 257.00
	FAB-6012b FAB-6014b	Floor to floor mounting. Flat bar profile aluminium guide rail, 900(H) x up to 900mm (W). 6mm Solid aluminium panel c/w fixing pack.	Mill RAL	B	£ 247.00 £ 275.00

We keep these barriers ex stock (depending on demand) at 900mm wide finished RAL 9006 Silver Grey.

Carriage £12.00 for the first barrier £5.00 for subsequent items.

See page 34 for premium carriage options.

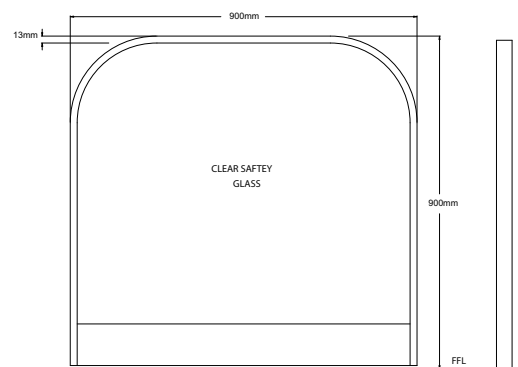
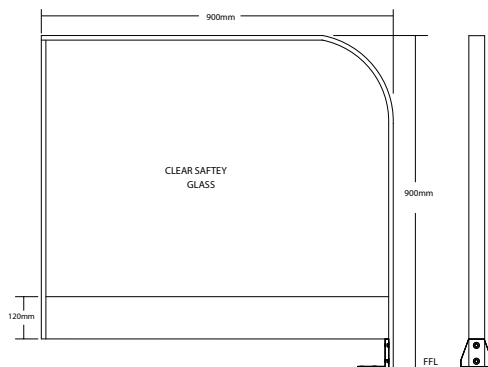

Product	ID Number	Description	Finish	Ref.	Up to 900 w	Up to 1200 w
	FAB-6022 FAB-6024	Floor to wall mounting. Flat bar profile aluminium guide rail Unglazed c/w adjustable mounting foot & fixing pack.	Mill RAL	B	£ 188.00 £ 221.50	£ 207.00 £ 235.50
	FAB-6022a FAB-6024a	Floor to wall mounting. Flat bar profile aluminium guide rail, Glazed 6mm Clear Safety Glass. c/w adjustable mounting foot & fixing pack.	Mill RAL	B	£ 228.50 £ 257.00	£ 261.50 £ 282.50
	FAB-6022b FAB-6024b	Floor to wall mounting. Flat bar profile aluminium guide rail 6mm Solid aluminium panel c/w adjustable mounting foot & fixing pack.	Mill RAL	B	£ 247.00 £ 275.50	£ 280.00 £ 305.50
	FAB-6032 FAB-6034	Floor to floor mounting. Flat bar profile aluminium guide rail Unglazed. c/w fixing pack.	Mill RAL	B	£ 188.00 £ 221.50	£ 207.00 £ 235.50
	FAB-6032a FAB-6034a	Floor to floor mounting. Flat bar profile aluminium guide rail, Glazed 6mm Clear Safety Glass. c/w fixing pack.	Mill RAL	B	£ 228.50 £ 257.00	£ 261.50 £ 282.50
	FAB-6032b FAB-6034b	Floor to floor mounting. Flat bar profile aluminium guide rail 6mm Solid aluminium panel c/w fixing pack.	Mill RAL	B	£ 247.00 £ 275.50	£ 280.00 £ 305.50

We manufacture barriers up to 1200mm wide to order. Glass is stocked in 100mm increments from 500mm wide to 1200mm. Intermediate sizes are possible but delivery will be extended.

Delivery 10 working days. Carriage £12.00 for the first barrier. £5.00 for subsequent items. Special manufacture sizes and colours cannot be returned.

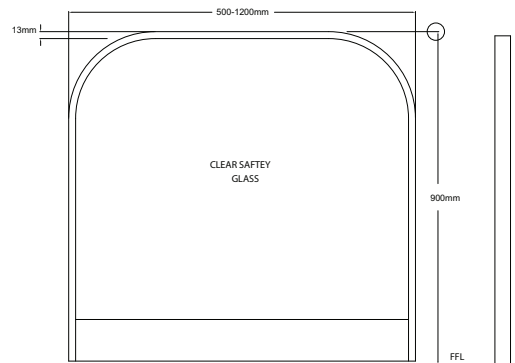
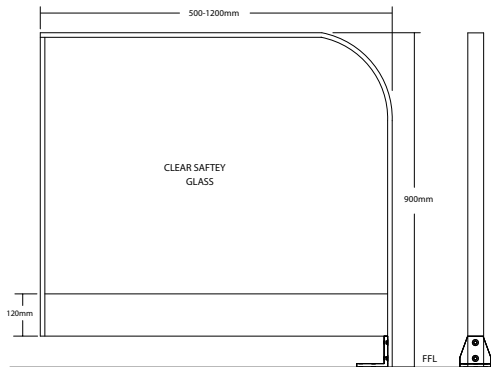

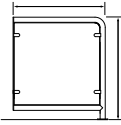
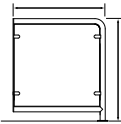
Product	ID Number	Description	Finish	Ref.	Price
	FAB-6122	Floor to wall mounting. Tubular stainless steel guide rail, 950(W) x 900mm(H). Available in Satin or Polished finish. Unglazed.	Satin	G	£ 395.00
	FAB-6122a	Floor to wall mounting. Tubular stainless steel guide rail, 950(W) x 900mm(H). Available in Satin or Polished finish. Glazed with 6mm clear toughened glass.	Satin	G	£ 486.00
	FAB-6122b	Floor to wall mounting. Tubular stainless steel guide rail, 950(W) x 900mm(H). Available in Satin or Polished finish. Glazed with solid panel.	Satin	G	£ 566.00
	FAB-6132	Floor to floor mounting. Tubular stainless steel guide rail, 950(W) x 900mm(H). Available in Satin or Polished finish. Unglazed, c/w std mounting foot.	Satin	G	£ 355.00
	FAB-6132a	Floor to floor mounting. Tubular stainless steel guide rail, 950(W) x 900mm(H). Available in Satin or Polished finish. Glazed with 6mm clear toughened glass.	Satin	G	£ 446.00
	FAB-6132b	Floor to floor mounting. Tubular stainless steel guide rail, 950(W) x 900mm(H). Available in Satin or Polished finish. Glazed with solid panel.	Satin	G	£ 525.00
	FAB-6140 FAB-6141 FAB-6142	All glass barrier with anodised silver base profile. Recommended only for slider back edge protection. Up to 900mm All glass barrier with anodised silver base profile. Recommended only for slider back edge protection. Up to 1200mm All glass barrier with anodised silver base profile. Recommended only for slider back edge protection. Up to 1500mm		G	£ 224.50 £ 245.00 £ 275.50

Stainless Barriers are manufactured to order. approx 4-5 weeks. It is not possible to send glazed types via standard carrier service. We recommend purchasing hoop only with glass template and having glass supplied locally. Barriers come with glass fixings.

Collection available from Essex and West Midlands.

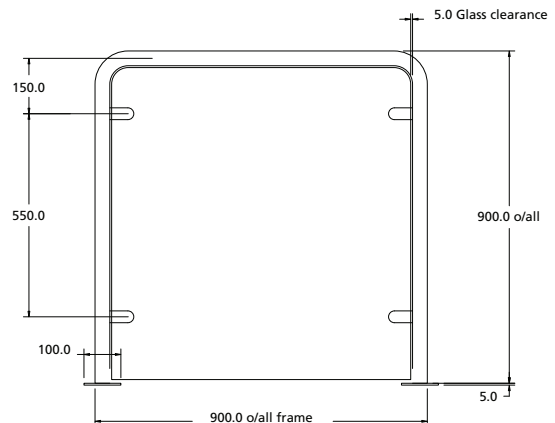
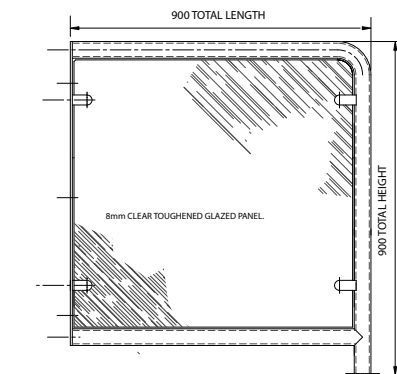



iOpen offers an economic solution for remote gate and door activation from any location worldwide by a GSM phone. No call costs are involved and the unit offers almost unlimited users. See page 32



iContact®ECO provides end-to-end “wire-free” GSM GPRS solutions for virtually every application including commercial M2M asset management through to vehicle tracking and loneworker monitoring. If precise remote asset management with accurate data is critical to your business, contact us now for full details.

Product	ID Number	Description	Ref.	Price
	SAP-2000 PLAIN-STD	Stainless Steel Jamb Push Pad, 38(W) x 115mm(H). Without back box. No engraving, Std switch.	A	£ 32.50
	SAP-2000a PLAIN-STD	Stainless Steel Jamb Push Pad, 38(W) x 115mm(H). With black ABS back box. No engraving, Std switch.	A	£ 39.50
	SAP-2000b PLAIN-TX	Stainless Steel Jamb Push Pad, 38(W) x 115mm(H). With black ABS back box & transmitter 433 MHz. No engraving, Special low profile switch.	A	£ 71.50
	SAP-2002 HPTO-STD	Stainless Steel Jamb Push Pad, 38(W) x 115mm(H). Without back box. Engraving "PUSH TO OPEN & Disabled Logo", Std switch.	A	£ 32.50
	SAP-2002a HPTO-STD	Stainless Steel Jamb Push Pad, 38(W) x 115mm(H). With black ABS back box. Engraving "PUSH TO OPEN & Disabled Logo", Std switch.	A	£ 39.50
	SAP-2002b HPTO-TX	Stainless Steel Jamb Push Pad, 38(W) x 115mm(H). With black ABS back box & transmitter 433MHz. Engraving "PUSH TO OPEN & Disabled Logo". Special low profile switch.	A	£ 71.50
	SAP-2004 PTO-STD	Stainless Steel Jamb Push Pad, 38(W) x 115mm(H). Without back box. Engraving "PUSH TO OPEN", Std switch.	A	£ 32.50
	SAP-2004a PTO-STD	Stainless Steel Jamb Push Pad, 38(W) x 115mm(H). With black ABS back box. Engraving "PUSH TO OPEN", Std switch.	A	£ 39.50
	SAP-2004b PTO-TX	Stainless Steel Jamb Push Pad, 38(W) x 115mm(H). With black ABS back box & transmitter 433MHz. Engraving "PUSH TO OPEN", Special low profile switch.	A	£ 71.50
	SAP-2008a ACC	Back box only, Black ABS to suit Jamb Push Pad for Surface Mounting.	A	£ 9.00
	SAP-2008b ACC-TX	Back box only, Black ABS to suit Jamb Push Pad for Surface Mounting. Complete with transmitter 433MHz.	A	£ 39.50
	SAP-2008c	Back box only, Metal to suit Jamb Push Pad for Flush Mounting.	A	£ 18.00

Push Pad Activation Switches

115mm Square

Product	ID Number	Description	Ref.	Price
	SAP-2010 PLAIN-STD	Stainless Steel Square Push Pad with adaptor plate, 115mm Sq. Without back box. No engraving, Std switch.	A	£ 39.50
	SAP-2010a PLAIN-STD	Stainless Steel Square Push Pad with adaptor plate, 115mm Sq. With black ABS back box. No engraving, Std switch.	A	£ 59.50
	SAP-2010b PLAIN-TX	Stainless Steel Square Push Pad with adaptor plate, 115mm Sq. With black ABS back box & transmitter 433MHz. No engraving, Std switch.	A	£ 85.50
	SAP-2012 HPTO-STD	Stainless Steel Square Push Pad with adaptor plate, 115mm Sq. Without back box. Engraving "PRESS TO OPEN & Disabled Logo", Std switch.	A	£ 39.50
	SAP-2012a HPTO-STD	Stainless Steel Square Push Pad with adaptor plate, 115mm Sq. With black ABS back box. Engraving "PRESS TO OPEN & Disabled Logo", Std switch.	A	£ 59.50
	SAP-2012b HPTO-TX	Stainless Steel Square Push Pad with adaptor plate, 115mm Sq. With black ABS back box & transmitter 433MHz. Engraving "PRESS TO OPEN & Disabled Logo". Std switch.	A	£ 85.50
	SAP-2014 PTO-STD	Stainless Steel Square Push Pad with adaptor plate, 115mm Sq. Without back box. Engraving "PRESS TO OPEN", Std switch.	A	£ 39.50
	SAP-2014a PTO-STD	Stainless Steel Square Push Pad with adaptor plate, 115mm Sq. With black ABS back box. Engraving "PRESS TO OPEN", Std switch.	A	£ 59.50
	SAP-2014b PTO-TX	Stainless Steel Square Push Pad with adaptor plate, 115mm Sq. With black ABS back box & transmitter 433MHz. Engraving "PRESS TO OPEN", Std switch.	A	£ 85.50
	SAP-2012a LED	Stainless steel Square push pad with illuminated adaptor plate, 115mm square. With ABS back box. Engraving "PRESS TO OPEN & Disabled Logo" Illumination 12-24VDC	A	£ 68.75
	SAP-2014a LED	Stainless steel Square push pad with illuminated adaptor plate, 115mm square. With ABS back box. Engraving "PRESS TO OPEN" Illumination 12-24VDC	A	£ 68.75

Product	ID Number	Description	Ref.	Price
	SAP-2018 PLAIN-STD	Stainless Steel Round Push Pad with adaptor plate, 115mm Dia. Without back box. No engraving, Std switch.	A	£ 39.50
	SAP-2018a PLAIN-STD	Stainless Steel Round Push Pad with adaptor plate, 115mm Dia. With black ABS back box. No engraving, Std switch.	A	£ 59.50
	SAP-2018b PLAIN-TX	Stainless Steel Round Push Pad with adaptor plate, 115mm Dia. With black ABS back box & transmitter 433MHz. No engraving, Std switch.	A	£ 85.50
	SAP-2020 HPTO-STD	Stainless Steel Round Push Pad with adaptor plate, 115mm Dia. Without back box. Engraving "PRESS TO OPEN & Disabled Logo", Std switch.	A	£ 39.50
	SAP-2020a HPTO-STD	Stainless Steel Round Push Pad with adaptor plate, 115mm Dia. With black ABS back box. Engraving "PRESS TO OPEN & Disabled Logo", Std switch.	A	£ 59.50
	SAP-2020b HPTO-TX	Stainless Steel Round Push Pad with adaptor plate, 115mm Dia. With black ABS back box & transmitter 433MHz. Engraving "PRESS TO OPEN & Disabled Logo". Std switch.	A	£ 85.50
	SAP-2022 PTO-STD	Stainless Steel Round Push Pad with adaptor plate, 115mm Dia. Without back box. Engraving "PRESS TO OPEN", Std switch.	A	£ 39.50
	SAP-2022a PTO-STD	Stainless Steel Round Push Pad with adaptor plate, 115mm Dia. With black ABS back box. Engraving "PRESS TO OPEN", Std switch.	A	£ 59.50
	SAP-2022b PTO-TX	Stainless Steel Round Push Pad with adaptor plate, 115mm Dia. With black ABS back box & transmitter 433MHz. Engraving "PRESS TO OPEN", Std switch.	A	£ 85.50
	SAP-2026 ACC	Mounting kit, enables 115mm surface back box to be flush mounted. Kit includes ABS black ring, metal bracket and fasteners.	A	£ 18.50
	SAP-2026a ACC	Back box only, Black ABS to suit 115mm Round Push Pad for Surface Mounting. Without adaptor plate.	A	£ 17.50
	SAP-2026c ACC	Back box only, Metal with conduit knockouts to suit 115mm Round Push Pad for Flush Mounting.	A	£ 6.93

Push Pad Activation Switches

152mm Square

Product	ID Number	Description	Ref.	Price
	SAP-2030 PLAIN-STD	Stainless Steel Square Push Pad with adaptor plate, 152mm Sq. Without back box. No engraving, Std switch.	A	£ 39.50
	SAP-2030a PLAIN-STD	Stainless Steel Square Push Pad with adaptor plate, 152mm Sq. With black ABS back box. No engraving, Std switch.	A	£ 59.50
	SAP-2030b PLAIN-TX	Stainless Steel Square Push Pad with adaptor plate, 152mm Sq. With black ABS back box & transmitter 433MHz. No engraving, Std switch.	A	£ 85.50
	SAP-2032 HPTO-STD	Stainless Steel Square Push Pad with adaptor plate, 152mm Sq. Without back box. Engraving "PRESS TO OPEN & Disabled Logo", Std switch.	A	£ 39.50
	SAP-2032a HPTO-STD	Stainless Steel Square Push Pad with adaptor plate, 152mm Sq. With black ABS back box. Engraving "PRESS TO OPEN & Disabled Logo", Std switch.	A	£ 59.50
	SAP-2032b HPTO-TX	Stainless Steel Square Push Pad with adaptor plate, 152mm Sq. With black ABS back box & transmitter 433MHz. Engraving "PRESS TO OPEN & Disabled Logo". Std switch.	A	£ 85.50
	SAP-2034 PTO-STD	Stainless Steel Square Push Pad with adaptor plate, 152mm Sq. Without back box. Engraving "PRESS TO OPEN", Std switch.	A	£ 39.50
	SAP-2034a PTO-STD	Stainless Steel Square Push Pad with adaptor plate, 152mm Sq. With black ABS back box. Engraving "PRESS TO OPEN", Std switch.	A	£ 59.50
	SAP-2034b PTO-TX	Stainless Steel Square Push Pad with adaptor plate, 152mm Sq. With black ABS back box & transmitter 433MHz. Engraving "PRESS TO OPEN", Std switch.	A	£ 85.50
	SAP-2046 ACC	Mounting kit, enables 152mm surface back box to be flush mounted. Kit includes ABS black ring, metal bracket and fasteners.	A	£ 18.50
	SAP-2046a ACC	Back box only, Black ABS to suit 152mm Square Push Pad for Surface Mounting. Without adaptor plate.	A	£ 17.50
	SAP-2026c ACC	Back box only, Metal with conduit knockouts to suit 152mm Square Push Pad for Flush Mounting.	A	£ 6.93

Push Pad Activation Switches

152mm Round

Product	ID Number	Description	Ref.	Price
	SAP-2038 PLAIN-STD	Stainless Steel Round Push Pad with adaptor plate, 152mm Dia. Without back box. No engraving, Std switch.	A	£ 39.50
	SAP-2038a PLAIN-STD	Stainless Steel Round Push Pad with adaptor plate, 152mm Dia. With black ABS back box. No engraving, Std switch.	A	£ 59.50
	SAP-2038b PLAIN-TX	Stainless Steel Round Push Pad with adaptor plate, 152mm Dia. With black ABS back box & transmitter 433MHz. No engraving, Std switch.	A	£ 85.50
	SAP-2040 HPTO-STD	Stainless Steel Round Push Pad with adaptor plate, 152mm Dia. Without back box. Engraving "PRESS TO OPEN & Disabled Logo", Std switch.	A	£ 39.50
	SAP-2040a HPTO-STD	Stainless Steel Round Push Pad with adaptor plate, 152mm Dia. With black ABS back box. Engraving "PRESS TO OPEN & Disabled Logo", Std switch.	A	£ 59.50
	SAP-2040b HPTO-TX	Stainless Steel Round Push Pad with adaptor plate, 152mm Dia. With black ABS back box & transmitter 433MHz. Engraving "PRESS TO OPEN & Disabled Logo". Std switch.	A	£ 85.50
	SAP-2042 PTO-STD	Stainless Steel Round Push Pad with adaptor plate, 152mm Dia. Without back box. Engraving "PRESS TO OPEN", Std switch.	A	£ 39.50
	SAP-2042a PTO-STD	Stainless Steel Round Push Pad with adaptor plate, 152mm Dia. With black ABS back box. Engraving "PRESS TO OPEN", Std switch.	A	£ 59.50
	SAP-2042b PTO-TX	Stainless Steel Round Push Pad with adaptor plate, 152mm Dia. With black ABS back box & transmitter 433MHz. Engraving "PRESS TO OPEN", Std switch.	A	£ 85.50
	SAP-2026d	Back box adaptor plate only, Black ABS to suit 115mm Square Pad.	A	£ 9.75
	SAP-2046d	Back box adaptor plate only, Black ABS to suit 152mm Square Pad.	A	£ 9.75
	SAP-2026e	Back box adaptor plate only, Black ABS to suit 115mm Round Pad.	A	£ 7.00
	SAP-2046e	Back box adaptor plate only, Black ABS to suit 152mm Round Pad.	A	£ 7.00

Product	ID Number	Description	Ref.	Price
	SAP-2008b	Back box only, Black ABS to suit Jamb Push Pad for Surface Mounting. Complete with Larco transmitter 433MHz.	A	£ 38.50
	SAP-2026b SAP-2046b	Back box only, Black ABS to suit 115mm Square or Round Push Pad for Surface Mounting. With adaptor plate. 152mm Complete with Larco transmitter 433MHz.	A	£ 52.00 £ 52.00
	SAP-2052d SAP-2261	Larco desk mount transmitter. Use with SAP-2050 receiver. White retractive switch in box only	A	£ 42.50 £ 8.95
	SAP-2052	Radio transmitter 433MHz Ultra small PCB to suit push pads. No case.	A	£ 31.50
	SAP-2054	Radio transmitter 433MHz Ultra small hand held key fob. Single Channel, Two button, Rolling code.	A	£ 31.50
	SAP-2056	Radio transmitter 433MHz hand held with easy push button. Single Channel, One button, Rolling code.	A	£ 64.50
	SAP-2058	Radio transmitter 433MHz hand held with easy push buttons. Two Channel, Two button, Rolling code.	A	£ 68.50
	SAP-2060	Radio transmitter 433MHz hand held with easy push buttons. Four Channel, Four button, Rolling code.	A	£ 82.50
	SAP-2050	Radio Receiver 433MHz Ultra small, Complete with wiring loom. Rolling code self learning. Upto 12 separate transmitters can be coded to one receiver. Dual voltage n/o and n/c relay output.	A	£ 39.50
	SAP-4124	BEA Large button Transmitter - Easy to use for those with dexterity problems. Use with SAP 4125 receiver.	C	£ 39.50
	SAP-4125	BEA Receiver 12-24Volt pulse output	C	£ 61.50
	SAP-4206	Transmitter for use in push pads. To suit BEA Receiver SAP-4125, complete with battery.	C	£ 46.50

Product	ID Number	Description	Ref.	Price
	SAP-2220	Key Switch 3 Position with Stainless faced Legend Plate. 38(w) x 115(h)mm, 2 Keys. Without back box, engraved Hold Open / Off / Auto.	CK D	£ 26.25
	SAP-2220a	Key Switch 3 Position with Stainless faced Legend Plate. 38(w) x 115(h)mm, 2 keys. With black ABS back box, engraved Hold Open / Off / Auto.	CK D	£ 34.50
	SAP-2207	Key Switch 2 Position with Stainless faced Legend Plate. 38(w) x 115(h)mm, 2 keys. Without back box. No Engraving.	CK D	£ 18.95
	SAP-2207a	Key Switch 2 Position with Stainless faced Legend Plate. 38(w) x 115(h)mm 2 keys. With black ABS back box. No Engraving.	CK D	£ 27.50
	SAP-2209	Key Switch Momentary with Stainless faced Legend Plate. 38(w) x 115(h)mm, 2 keys. Without back box. No Engraving.	CK D	£18.95
	SAP-2209a	Key Switch Momentary with Stainless faced Legend Plate. 38(w) x 115(h)mm 2 keys. With black ABS back box. No Engraving.	CK D	£ 27.50
	SAP-2211	Key Switch 2 Position with Stainless faced Legend Plate. 38(w) x 115(h)mm, 2 keys. Without back box. Engraved On / Off.	CK D	£ 21.95
	SAP-2211a	Key Switch 2 Position with Stainless faced Legend Plate. 38(w) x 115(h)mm, 2 keys. With back box. Engraved On / Off.	CK D	£ 30.20
	SAP-2240	Key switch 4 position with Stainless faced plate 38 (w) x 115 Engraved "off", 2 way, 1 way, Hold Open.	CK D	£ 31.50
	SAP-2240a	As SAP-2240 plus back box	CK D	£ 39.50
	ACC-0303	Spare keys for switch (sold singly)	TOK C	£ 6.35
	ACC-0306	Spare keys for switch (sold singly)	RS C	£ 3.17
	ACC-0315-606	Spare key for 2 & 3 position CK switches	CK D	£ 2.65
	ACC-0315-614	Spare key for momentary CK switches	CK D	£ 2.65
	ACC-0315-126	Spare key for 4 position CK switches	CK D	£ 2.65
	SAP-2242	Key switch 4 position for replacement of Uni slide original equipment. On plate with legend.	CK A	£ 61.75

All CK switches come with soldered wiring loom.

Bespoke engraved key switch plates available to order

Product	ID Number	Description	Ref.	Price
	SAP-2250	Push Button Green Domed Robust with Stainless Steel Legend Plate, 38(w) x 115(h)mm. Without back box. Engraved Press to Open.	B	£ 30.00
	SAP-2250a	Push Button Green Domed Robust with Stainless Steel Legend Plate, 38(w) x 115(h)mm. With black ABS back box. Engraved Press to Open.	B	£ 38.50
	SAP-2252	Push Button Green Domed Robust with Stainless Steel Legend Plate, 85(w) x 85(h)mm With flush back box. Screen printed Press to Open.	B	£ 25.50
	SAP-2252a	Push Button Green Domed Robust with Stainless Steel Legend Plate, 85(w) x 85(h)mm. With flush single gang metal back box & surface frame. Screen printed Press to Open.	B	£ 33.50
	SAP-2090	Elbow switch robust ABS with sealed micro switch 250mm H x 95mm W x 22mm D.	B	£ 39.00
	SAP-2092	As above but with stainless pad facing.		£ 54.00
	SAP-2093	Elbow switch in extruded aluminium. Very tough with double sealed micro switches. 250mm H x 95mm W x 22mm D.	B	£ 89.50
	SAP-2263	Ventilation control switch suits 24Volt reverse polarity - max 10 amp switching on 85 (w) x 85 (L) mm stainless plate.	D	£ 21.50
	SAP-2263a	As above complete with simulated stainless surface housing.	D	£ 30.50
	SAP-2264	Ventilation control switch suits 24Volt reverse polarity - max 10 amp switching on 38 (w) x 85 (L) mm stainless plate.	D	£ 21.50
	SAP-2264a	As above complete with simulated stainless surface housing.	D	£ 30.50
	SAP-2261	Piezo action press switch with "Press to exit" engraving with 2 colour halo illumination.	B	£ 89.50
	SAP-2261a	Piezo action press switch with "Press to exit" engraving complete with surface housing in simulated stainless.	B	£ 98.50
	SAP-2262	Push button with 2 colour halo illumination. Engraved "Press to Exit"	B	£ 65.50
	SAP-2262a	Push button with 2 colour halo illumination. Engraved "Press to Exit" complete with surface housing in simulated stainless steel.	B	£ 74.50

Bollards

Product	ID Number	Description	Ref.	Price
	SAP-2061	Larco aluminium bollard without cut out finished in silver with black ABS cap. With mounting feet 1016mm high x 100mm x 150mm	A	£ 180.00
	SAP-2062	LARCO aluminium bollard with cut out to suit switch. With mounting feet 1016mm High x 100mm x 150mm	A	£ 208.90
	SAP-2062T	Larco aluminium bollard with 2 cut outs. Lower cut out prepared to receive standard call point (BGU). With mounting feet 1016mm high x 100mm x 150mm	A	£ 228.90
	SAP-2062a	LARCO aluminium bollard with cut out for standard switch Finished in silver with black ABS cap With mounting feet 1016mm High x 100mm x 150mm Complete with switch engraved "Press to Open & Logo"	A	£ 248.40
	SAP-2062b	LARCO aluminium bollard with cut out for standard switch Finished in silver with black ABS cap With mounting feet 1016mm High x 100mm x 150mm Complete with switch engraved "Press to Open & Logo" Including radio transmitter	A	£ 279.90
	SAP-2074a SAP-2074b	LARCO style bollard manufactured from 304 stainless steel, complete with switch engraved "Press to Open & Logo". As above and fitted with transmitter.	B	£ 353.90 £ 384.40
	SAP-2080	Stainless steel bollard 130mm diameter x 950mm high complete with bolt down mounting plate. Top angled at 45 degrees.	B	£ 330.00
	SAP-2080a	Stainless steel bollard 130mm diameter x 950mm high complete with bolt down mounting plate. Top angled at 45 degrees. Complete with switch engraved "Press to Open & Logo"	B	£ 390.00
	SAP-2080b	Stainless steel bollard 130mm diameter x 950mm high complete with bolt down mounting plate. Top angled at 45 degrees. Complete with switch engraved "Press to Open & Logo" Including radio transmitter	B	£ 416.00
	SAP-2084	Larco 304 grade stainless switch post 48mm diameter 1020mm high to suit Larco 4.5" or 6" transmitter (only) switches (not included). Internal use only.	A	£ 102.00
	SAP-2085 SAP-2085c	Steel post with cranked top to suit card readers or keypads. 1100Mm high with 120 x 220mm faceplate. Bolt down footplate. Finished black PPC. As above finished Orange PPC. (Illustrated)	A	£ 115.00
	SAP-2100	Stainless steel post (304 grade) 150mm diameter x 1500mm high with a range of faceplates available to suit, push pads, proximity, intercom etc. See web for variety.	B	£ 828.50

Activation and Safety Sensors

Pedestrian & Industrial - Reglomat





Product	ID Number	Description	Ref.	Price
	SAP-4072	Reglomat Merkur with Direction recognition. Easy set up and adjustment via Reglobeam controller (not included). Suits application on swing side of swing door.	M	£ 122.50
	SAP-4073	Reglomat Reglobeam remote controller for Merkur.	M	£ 39.50
	SAP-4070	Reglomat Mars 31 Non direction horn antenna radar. Industry standard radar. No remote required for set up. Max mount height 4m.	M	£ 84.00
	SAP-4074	Weather cover for Mars.	M	£ 20.50
	SAP-4075	Weather cover for Merkur.	M	£ 21.50
	SAP-4094	Reglomat swing door safety sensor 330mm long. G3.	M	£ 116.50
	SAP-4094L	As above complete with ACC-0404 black door transfer loop.	M	£ 123.50
	SAP-4096	Reglomat swing door safety sensor (single card) 900mm long. G3.	M	£ 132.50
	SAP-4096L	As above with ACC-0404 black door transfer loop	M	£ 139.50
	SAP-4078 NEW	Thro-beam active infra red sensors with 12mm hole fixing. 6M range, plug in connectors, 10-30volt supply PNP or NPN output, IP65 housing	M	£ 68.75
	SAP-4084 NEW	Hercules Industrial high mount (2-7M) radar. Direction logic. Distinguishes between vehicles and pedestrians. 12-28vAC – 12-36vDC, IP65 with 5M cable.	M	£ 172.20
	SAP-4079 SAP-4080 NEW	Proloop 11, single inductive loop controller with 11 pin connection Fully programmable by push buttons and LCD display, integral loop inductance test, sensitivity available, auto sense boost, galvanic isolation between loop and detector. Supply 24vAC/DC with relay output. As above with dual loop input.	M	£ 115.50 £ 138.25
	SAP-4081	Base to suit SAP-4079 & SAP-4080	M	£ 5.25
	SAP-4082	Pre-assembled loop, circumference 6 meter, supply cable 15 meters.	M	£ 167.75
	SAP-4083 NEW	As above with 12 meter circumference.	M	£ 181.95
	SAP-4085 NEW	We now offer a full range of curly cables in 3,4 & 5 cores up to 4500mm fully extended. Please see web for full selection.	M	P.O.A.
	SAP-4086 NEW	A full range of connection boxes for the curly cables. Please see web for full selection	M	P.O.A.
	SAP-4087 NEW	Safety edge profile in a variety of sizes and profiles. Please see web for full selection	M	P.O.A.

Product	ID Number	Description	Ref.	Price
	SAP-4416 <i>NEW</i>	Optex OM 106C, Uni-directional radar for wall or ceiling mount. May be used on the swing side of swing door applications above the pivot point.	C	£ 101.50
	SAP-4417 <i>NEW</i>	Optex OM 105C, Bi-directional radar for wall or ceiling mount.	C	£ 99.50
	SAP-4402	Set of beams only to suit SAP-4403 & SAP-4404	C	£ 23.75
	SAP-4403	The Optex safety beam consists of a separate amplifier (OS-12C) and a single set of safety beam heads. The safety beam has a one touch learn button for easy set-up.	C	£ 75.50
	SAP-4404	The Optex safety beam consists of a separate amplifier (OS-12C) and small safety beam heads. Complete with 2 sets of safety beams. The safety beam has a one touch learn button for easy set-up.	C	£ 99.25
	SAP-4405	The Optex OA presence has single row presence detection for use as sliding door side screen protection. Black case	C	£ 81.00
	SAP-4406	The Optex OA-203C is a combination safety and activation sensor. The presence detection (safety) can be set by dip switches and the maximum setting is infinite. The safety field can be moved to -4° from the vertical. Black case	C	£ 96.50
	SAP-4415 <i>NEW</i>	The Optex AXIS I is a combination safety and activation sensor. Presence detection can be set ($\pm 10^\circ$) just in front of the door, so that the installation of safety beams is no longer necessary. Activation field can be set independently ($\pm 6^\circ$) so that an extra deep field is created. Black case	C	£ 110.50
	SAP-4414 <i>NEW</i>	The Optex AXIS II is a combination safety and activation sensor. All details as the AXIS I but with separate relay outputs. Black case	C	£ 118.50
	SAP-4413	Essential engineering tool for easy set up of the Optex infra-red sensors.	C	£ 39.50

Product	ID Number	Description	Ref.	Price
	SAP-4100	BEA Eagle 1 Uni-directional motion sensor Superb range of adjustment using the optional remote control.	B	£ 142.00
	SAP-4102	BEA Eagle 2 Bi-directional motion sensor	B	£ 111.50
	SAP-4128 SAP-4130	BEA Rain cover for Eagle 1 & 2 Ceiling housing for Eagle (not shown)	B	£ 23.00 £ 32.50
	SAP-4114OFF SAP-4114ON SAP-4114c SAP-4411	BEA Active 8.1 Off Uni-directional motion sensor + 2 AIR curtains BEA Active 8.1 On Uni-directional motion sensor + 2 AIR curtains Clear perspex weather cover for Active 8 Angle bracket for ceiling mounting Active 8	B	£ 239.00 £ 239.00 £ 30.95 £ 14.25
	SAP-4115 SAP-4116	Eyetech swing door safety sensor 340mm housing, finished silver. Eyetech swing door safety sensor 900mm housing, finished silver.	B	£ 154.00 £ 163.75
	SAP-4122 SAP-4123	BEA 4 safe on swing door sensor 340mm with 4 spots. Housing finished in black. BEA 4 safe on swing door sensor 900mm with 4 spots. Housing finished in black.	B	£ 183.95 £ 193.95
	SAP-4117 SAP-4121	Crystal presence side screen protection sensor Flush mounting accessory for crystal	B	£ 107.50 £ 32.00
	SAP-4104	BEA Remote control - Use with Eagle, 4 safe and active 8 for easy set up.	B	£ 15.50
	SAP-4126	BEA Spot finder. Locate IR spots exactly with this engineering tool.	B	£ 68.00
	SAP-4127	BEA Magic switch - Radar sensor offering adjustable sensing from 25-600mm	B	£ 114.50
	SAP-4409	BEA Fly sensor - very small PIR activation.	B	£ 134.50
	SAP-4410	BEA Housing for Fly sensor - Flush mounting.	B	£ 13.50

Product	ID Number	Description	Ref.	Price
	SAP-4040	RMS-D Direction radar suitable for swing door applications on the swing side. Easy set up by Dip switch with no remote control.	S	£ 84.50
	SAP-4042	Combined weather cover and ceiling mount for the SAP-4040 RMS-D radar sensor.	S	£ 24.25
	SAP-5000	Swing door safety sensor 340mm with optional monitored function. Silver housing	S	£ 95.50
	SAP-5000L <i>NEW</i>	Swing door safety sensor 340mm with optional monitored function. Silver housing, complete with ACC-404 door loop.	S	£ 103.00
	SAP-5001 <i>NEW</i>	Swing door safety sensor 900mm single card with optional monitored output. Silver housing.	S	£ 99.50
	SAP-5001L <i>NEW</i>	Swing door safety sensor 900mm single card with optional monitored output. Silver housing, complete with ACC-404 door loop.	S	£ 107.00
	SAP-5000 lens <i>NEW</i>	Spare 1M lense to suit SAP 5000 or SAP 5001. Easily cut to length.	S	£ 20.72
	SAP-5000 Cap	Pair of end caps to suit SAP-5000 or SAP 5001	S	£ 6.00
	SAP-4045	Reflective photocell detector with 12M range. IP67 range, c/w 84mm dia reflector. 12-230Volt AC/DC supply.	B	£ 57.50

Product	ID Number	Description	Ref.	Price
	SAP-4006	SSS-1S1 - Active Infra-red Presence Sensor Kit. Swing door safety sensor 340mm long c/w 1 master PCB. Std. Colour Black. Alternative product see SAP-5000 page 17.	B	£ 134.00
	SAP-4008	SSS-1L1 - Active Infra-red Presence Sensor Kit. Swing door safety sensor 900mm long c/w 1 master PCB. Std. Colour Black. Alternative product see SAP-5001 page 17.	B	£ 160.00
	SAP-4001 SAP-4001a	HR94D1 - Active Infra-red Presence Sensor. Single row detection area ideal for side screen safety applications. Std. Colour Black, also available in Silver ID SAP-4001a. Alternative product see SAP-4405 page 18.	B	£ 95.75
	SAP-4012	HR100 - Active Infra-red Combination Activation and Presence Sensor. 5 row detection area split for safety and long range activation with single relay output. Std. Colour Black. Alternative product see SAP-4415 page 18.	B	£ 126.50
	SAP-4014	HR100-2 - Active Infra-red Combination Activation and Presence Sensor. 5 row detection area split for safety and long range activation with two separate relay outputs. Std. Colour Black. Alternative product see SAP-4414 page 18.	B	£ 144.00
	SAP-4004 SAP-4004a	SSP-R1 - Active Infrar-ed Combination Activation and Presence Sensor. 5 row detection area with facility to look back. Std. Colour Black, also available in Silver ID SAP-4004a. Alternative product see SAP-4414 page 18.	B	£ 133.00
	SAP-4017	HR82C Active Infra-red Presence Sensor for ceiling mounting.	B	£ 151.00
	SAP-4002 SAP-4003	BP2-2 - Safety Beams Sensor. Controller complete with one set of beam, high resistance to reflection from sunlight. As above with 2 beams.	B	£ 61.50 £ 71.50
	SAP-4005a	HZC-CS-BC - Ultrasonic Presence Sensor. Controller with constant sensing facility only.	B	£ 199.50
	SAP-4005b	HZC-1SR - Ultrasonic Presence Sensor. Sensor head only Short Range.	B	£ 59.50
	SAP-4005c	HZC-1LR - Ultrasonic Presence Sensor. Sensor head only Long Range.	B	£ 59.50

Product	ID Number	Description	Ref.	Price
	SAP-2260	Robust foot switch for harsh environments requiring fully sealed item.	A	£ 51.25
	SAP-4031	Pull switch, industrial heavy duty unit with 1m chain.	B	£ 42.00
	SAP-4203	AuVis audible and visual warning sensor yellow incl. back & accelerometer	B	£ 76.50
	ACC-1656	Boxed force gauge with 0-200N range. Peak value hold feature and push/pull accessories.	B	£ 141.50



The new Combi-post offers adaptable use from a stock item. We stock various front plates to suit push pads, keypads, proximity readers etc. 304 grade stainless steel at 1500mm high x 150mm diameter. Concealed base.

Toilet Entry system – Touch switch

Product	ID Number	Description	Ref.	Price
	SAP-4455 SAP-4455b	Architrave wedge unit, hard wired connection with high visibility LED and confidence tone sounder. Graphics with Door Assist text. Architrave wedge unit, 433MHz radio transmitter Graphics with Door Assist text.	K	£ 67.50 £ 77.50
	SAP-4453 SAP-4453t SAP-4453te	Round wedge touch switch, hard wired connection with high visibility LED and confidence tone sounder. May be oriented to suit user approach. Graphics with Door Assist text. As above with "Touch to lock – Touch to Open" As above with "WC Door - Assist" with key override.	K	£ 70.25 £ 70.25 £ 90.25
	SAP-4462 SAP-4463	Round wedge touch switch. May be orientated to suit user approach. Graphics with "Touch to Open" Acrylic or Stainless Steel label . As above with transmitter	K	£ 67.50 £ 77.50
	SAP-4456 SAP-4456b	Glass mount touch switch. Suitable for single or double glazed units excluding glass with Low E metallic coatings. Hard wired connection with high visibility LED and confidence tone sounder. Graphics with Door Assist text. As above with 433MHz transmitter.	K	£ 82.00 £ 92.00
	SAP-4452 SAP-4452t SAP-4452te	Single gang touch switch, internal use only, hard wired connection with high visibility LED and confidence tone sounder. May be mounted surface or flush. Graphics with Door Assist text. As above with "Touch to lock – Touch to Open" As above with "WC Door - Assist" with key override	K	£ 70.25 £ 70.25 £ 90.25
	SAP-4457	Receiver to suit wireless touch switches	K	£ 37.00
	SAP-4454	PCB only for WC control. Outputs for auto door and lock. Inputs for touch switches and door contact. 12V DC input.	K	£ 120.50
	SAP-4450	Complete WC entry kit comprising 1 x SAP-4452t, 1 x SAP-4452te, 1 x SAP-4454, Break glass unit and key override Monitored magnet lock. Switches suitable for internal mounting in standard single gang flush or surface boxes (not supplied) 12V Battery backed PSU	K	£ 425.00
	SAP-4451	Complete WC entry kit comprising 1 x SAP-4453t, 1 x SAP-4453te, 1 x SAP-4454, Break glass unit and key override Monitored magnet lock. Switches suitable for external mounting at selectable angle. 12V Battery backed PSU	K	£ 425.00
	SAP-4459	Touch switch 5mm Acrylic faced. With legend "Door Release" 86 x 86mm to fit standard single gang box, surface or flush	K	£ 47.00
	SAP-4460	Indicator unit 5mm Acrylic faced. With legend "Engaged - Vacant" 86 x 86mm to fit standard single gang box, surface or flush	K	£ 57.50
	SAP-4461	Indicator unit 5mm Acrylic faced. With legend "Engaged – Vacant" and override switch. 86 x 86mm to fit standard single gang box, surface or flush	K	£ 79.50







Finger Protection

Product	ID Number	Description	Ref.	Price
	ACC-0100	Finger Guard - Roller blind style for hinged or pivoted door protection. Black Fabric blind with Silver Anodised case. Blind extension 250mm maximum, case length 1925mm.	B	£ 139.00
	ACC-0101	Finger Guard - Roller blind style for hinged or pivoted door protection. Black Fabric blind with Dark Bronze case. Blind extension 250mm maximum, case length 1925mm.	B	£ 139.00
	ACC-0102	Finger Guard - Roller blind style for hinged or pivoted door protection. Black Fabric blind with White case. Blind extension 250mm maximum, case length 1925mm.	B	£ 139.00
	ACC-0112	Finger Guard - Roller blind style for hinged or pivoted door protection. Silver Anodised - Black PVC wipe clean blind. Tested to > 1 Million cycles, hinged case for pinch hazard prevention. Blind extension 150mm maximum, case length 1950mm.	B	£ 97.50
	ACC-0113	Finger Guard - Roller blind style for hinged or pivoted door protection. Black Anodised - Black PVC wipe clean blind. Tested to > 1 Million cycles, hinged case for pinch hazard prevention. Blind extension 150mm maximum, case length 1950mm.	B	£ 116.50
	ACC-0114	HingeSafe PVC anti finger trap for hinged doors - White Standard 1.95m length, fitted in minutes.	C	£ 32.00
	ACC-0115	HingeSafe PVC anti finger trap for hinged doors - Black Standard 1.95m length, fitted in minutes.	C	£ 32.00
	ACC-0116	HingeSafe PVC anti finger trap for hinged doors - Brown Standard 1.95m length, fitted in minutes.	C	£ 32.00
	ACC-0106	Finger Guard - Vinyl type 125mm for hinged or pivoted door protection Black. Length 2310mm	A	£ 53.21
	ACC-0107	Finger Guard - Vinyl type 255mm for hinged or pivoted door protection Black. Length 2310mm	A	£ 72.50
	ACC-0108	Finger Guard - 'D' shaped Vinyl type 25mm for pivoted door protection Black. Length 2440mm	A	£ 42.50
	ACC-0108c	D shaped finger guard with aluminium holder (black) (not shown) Length 2500mm	B	£ 45.00
	ACC-0126	Finger Guard - Profile holder and seal for glass door. Suits 10-12mm glass. Length 2500mm	B	£ 79.50

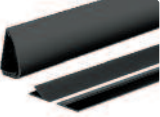
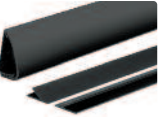
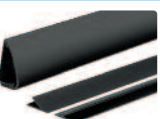
Roller finger guards available in RAL Colours.
(Minimum quantity applies at extra cost)

Hardware Accessories

Finger Protection - Pivot Doors

Product	ID Number	Description	Ref.	Price
	ACC-0118	PivotSafe for single swing leaf 2400mm long Mill	G	£ 74.25
	ACC-0119	PivotSafe for single swing leaf 2400mm long Silver Anodised	G	£ 95.50
	ACC-0120	PivotSafe for single swing leaf 2400mm long Bronze Anodised (to order)	G	POA
	ACC-0121	PivotSafe for single swing leaf 2400mm long RAL (to order)	G	POA
	ACC-0122	PivotSafe for double swing leaf 2400mm long Mill	G	£ 119.50
	ACC-0123	PivotSafe for double swing leaf 2400mm long Silver Anodised	G	£ 145.50
	ACC-0124	PivotSafe for double swing leaf 2400mm long Bronze Anodised (to order)	G	POA
	ACC-0125	PivotSafe for double swing leaf 2400mm long RAL (to order)	G	POA

The PivotSafe Solution

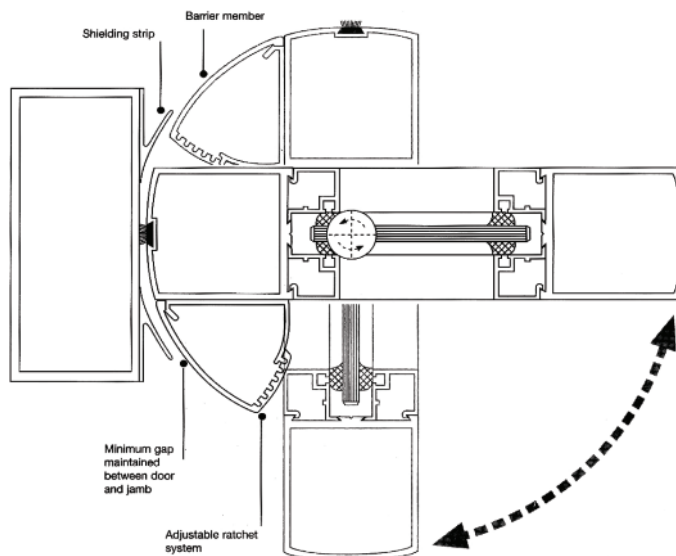

Legend Plates

Product	ID Number	Description	Ref.	Price
	ACC-1003	Legend plate only - Stainless steel effect with 3 holes to suit CK key switch. Engraved On/Off. To suit Jamb size back box - SAP-2008a or SAP-2008c. Excluding switch.	B	£ 7.15
	ACC-1004	Legend plate only - Stainless steel effect with 3 holes to suit CK key switch. Plain. To suit Jamb size back box - SAP-2008a or SAP-2008c. Excluding switch.	B	£ 5.35
	ACC-1005	Legend plate only - Stainless steel effect with 3 holes to suit RS key switch. Plain. To suit Jamb size back box - SAP-2008a or SAP-2008c. Excluding switch.	B	£ 5.35
	ACC-1008	Legend plate only - Stainless steel effect with 3 holes to suit CK key switch. Engraved Hold Open, Off, Auto. To suit Jamb size back box - SAP-2008a or SAP-2008c. Excluding switch.	B	£ 11.25
	ACC-1015	Legend plate only - Stainless steel effect with 3 holes to suit Green Domed switch. Engraved Press to Open. To suit Jamb size back box - SAP-2008a or SAP-2008c. Excluding switch.	B	£ 8.25
	ACC-1017	Legend plate only - Stainless steel effect with 3 holes to suit RS key switch. Engraved On / Off. To suit Jamb size back box - SAP-2008a or SAP-2008c. Excluding switch.	B	£ 7.15
	ACC-1019	Legend plate only - Stainless steel effect with 3 holes to suit TOK, CK or RS key switch. Engraved To suit your requirements. To suit Jamb size back box - SAP-2008a or SAP-2008c. Excluding switch.	B	£ 9.78
	ACC-1021	Legend plate only - Stainless steel effect with 3 holes to suit CK switch. Engraved, Off, 2way, 1 way, Hold Open	B	£ 13.10

Bespoke engraved key switch plates available to order

Signage

Product	ID Number	Description	Ref.	Price
	ACC-0001	Signage - Automatic Door, White with black lettering self adhesive	B	£ 0.45
	ACC-0002	Signage - Emergency Push to Open, Green with white lettering self adhesive	B	£ 1.75
	ACC-0003	Signage - Disabled Logo only, White with black lettering self adhesive	B	£ 0.45
	ACC-0004	Signage - Keep Clear, White with blue lettering self adhesive	B	£ 0.45
	ACC-0005	Signage - No Entry, White with red lettering self adhesive	B	£ 1.75
	ACC-0006	Signage - One Way, White with blue lettering self adhesive	B	£ 0.99
	ACC-0007	Signage - Power Assisted Door, White with black lettering self adhesive	B	£ 0.45
	ACC-0008	Signage - Power Assisted Door & Logo, White with black lettering self adhesive	B	£ 0.45
	ACC-0009	Signage – Push button to open.	B	£ 1.25
	ACC-0010	Signage (self adhesive) Double sided Auto Door white square black lettering	B	£ 0.75









Bespoke signage available with company logo and name, available to order

Product	ID Number	Description	Ref.	Price
	ACC-1025	Floor Guide - Double roller type. Suits std aluminium bottom rail door profile.	B	£ 12.50
	ACC-1027	Floor Guide - Single roller type 24mm dia.	B	£ 10.75
	ACC-1028	Floor Guide - Single roller type 23mm dia. Suits Comar Aluminium bottom channel CS51	B	£ 10.75
	ACC-1029	Floor Guide - Single roller type 21mm dia.	B	£ 10.75
	ACC-1033-10 ACC-1033-12	Floor Guide - Stainless steel 'U' channel with nylon insert to suit 10mm glass. As above to suit 12mm glass	B	£ 20.50
	ACC-1034	Adjustable Floor Guide - 23mm wide	B	£ 18.50
	ACC-1034a	As ACC-1034 but mounted on short plate	B	£ 18.50
	ACC-1035	Solid nylon block guide 17mm 25mm x 130mm	B	£ 13.75
	ACC-1038	To suit standard roller guides, enables fixing to jamb (LH)	B	£ 8.50
	ACC-1039	To suit standard roller guides, enables fixing to jamb (RH)	B	£ 8.50
	ACC-1040	3mm packer plate to suit standard floor guides	B	£ 3.35
	ACC-1041L ACC-1041R	Besam style floor guide mounted on angle plate for jamb fixing LH (<i>illustrated</i>) Besam style floor guide mounted on angle plate for jamb fixing RH	B B	£ 26.50 £ 26.50

Miscellaneous

Product	ID Number	Description	Ref.	Price
	ACC-0150 ACC-0151 ACC-0152 ACC-0183	1 Amp Power Supply 12 Volt, Steel Case White. 1 Amp Power Supply 24 Volt, Steel Case White. 3 Amp Power Supply 24 Volt, Steel Case White. 5 Amp Power Supply 24 Volt, Steel Case White.	B	£ 36.00 £ 65.00 £ 91.50 £ 169.50
	ACC-0181 ACC-0181b	1.5 Amp power supply 24 Volt. ABS case for wall mount, with conduit entry. 2.5 Amp power supply 12 Volt. ABS case for wall mount, with conduit entry.	B	£ 36.50
	ACC-0160	Pulse / Latching Relay 24VDC with 1n/o and 1n/c contact c/w manual override.	B	£ 38.55
	ACC-0161 ACC-0161a	Multipurpose miniature relay, 9-30 volt coil, diode protection. 2 separate coils each with single pole changeover contacts case only 60x45x18mm.(not shown) Open frame relay. 12-28v AC/DC DPCO. (pictured)	B	£ 22.15 £ 16.25
	ACC-0170 ACC-0172	UPS Mains Power Supply 650VA. UPS Mains Power Supply 800VA.	B	£ 150.00 £ 182.00
	ACC-0400 ACC-0402	Door transfer loop armoured surface fixed with cast end caps. Silver. As above with reinforced loop to withstand <100kg load.	B	£ 11.95 £ 21.25
	ACC-0404	Door transfer loop surface fixed with plastic end caps. Black loop/black end caps 600mm.	B	£ 7.50
	ACC-0405	Door transfer loop 500mm, nickle plated brass with plated ABS end caps.9mm outer, 7mm inner, 5.5mm through ferrule	B	£ 6.65
	ACC-0405SP ACC-0405EC	Door transfer loop available in 10m coil. End caps for loops (pack 10 pairs).	B	£ 75.00 £ 16.00
	ACC-0408	Door transfer loop armoured concealed fixed. Silver.	B	£ 15.50
	ACC-0412 ACC-0412d ACC-0412r ACC-0412t ACC-0412p	Green Breakglass for emergency door release - single pole. Double pole type. With deformable panel - double pole. Tamper cover. Deformable panel for ACC-0412.	B	£ 11.50 £ 15.50 £ 20.50 £ 4.84 £ 1.65
	ACC-0164 ACC-0175	Universal timer module 0-60 seconds range. Handy voltage reducer 24-12 Volt DC max 1A loading (not shown).	B	£ 28.50

Product	ID Number	Description	Ref.	Price
	HRD-8500	Overhead surface mounted door closer, Variable power EN 3/4 by O/H position. For doors upto 1100mm wide. Application Fig 1, 61 & 66. Silver.	E	£ 49.89
	HRD-8600	Overhead surface mounted door closer, Variable power adjustment EN 3,4,5. For doors upto 1250mm wide. Application Fig 1, 61 & 66. Silver.	E	£ 58.95
	HRD-8700	Overhead surface mounted door closer, Variable power adjustment EN 1-6. For doors upto 1400mm wide. Application Fig 1, 61 & 66. Silver.	E	£ 104.00
	HRD-8800-2 HRD-8800-3 HRD-8800-4	Overhead concealed mounted door closer. Available in sizes 2,3 & 4, mechanism only.	E	£ 73.50
	HRD-8800-2H HRD-8800-3H HRD-8800-4H	Overhead concealed mounted door closer. Available in sizes 2,3 & 4, mechanism only with hold open at 90 degrees	E	£ 73.50
	HRD-8804	Overhead concealed mounted door closer. Available in sizes 2,3 & 4, mechanism only. Extended 2.5mm spindle version to overcome draft seals.	E	£ 73.50
	HRD-8810	Overhead concealed mounted dummy door closer. Universal fixings to ease the replacement of all manufactures models, mechanism only.	E	£ 74.75
	HRD-8102	Panic Breakout stop with microswitch	E	£ 183.55
	HRD-8300S HRD-8300E	Side load pivot pack assembly includes top arm and bottom pivot. End load	E	£ 28.75 £ 28.75
	HRD-8310	Double action top centre pivot for metal doors with toe up & down adjustment.	E	£ 31.75
	HRD-8316	Double action top centre pivot for timber doors with toe up & down adjustment.	E	£ 31.75
	HRD-8320	Double Action top centre pivot for metal doors non adjustable.	E	£ 25.95

Product	ID Number	Description	Ref.	Price
	HRD-8900	Floor spring recessed mounted door closer, fixed EN 4, mechanism only. For doors upto 1100mm wide.	E	£ 124.75
	HRD-8910	Floor spring recessed mounted door closer, Variable power adjustment EN 2-5, mechanism only. For doors upto 1250mm wide.	E	£ 255.10
	HRD-8920 HRD-8922	Floor spring cover plate Satin Stainless Steel for HRD-8900. Floor spring cover plate Satin Stainless Steel for HRD-8910.	E	£ 15.75 £ 17.00
	HRD-8330	Double action bottom drive arm (strap).	E	£ 13.50
	HRD-8332	Single action offset bottom drive arm (strap).	E	£ 31.75
	HRD-8334	Single action offset top centre drive arm (strap).	E	£ 38.50
	HRD-8155	Double action free swing bottom pivot assembly to suit single or double action strap.	E	£ 15.95
	HRD-8100	Door Stop - Robust with aluminium silver anodised body and black rubber buffer.	E	£ 14.25

Product	ID Number	Description	Ref.	Price
	ACC-0200	Single slimline unmonitored maglock 12-24 Volt operation 250mm wide x 42mm high x 26mm deep. Current draw 24 Volt 300mA (600mA @ 12 Volt).	F	£ 38.50
	ACC-0202	As ACC-0200 and with monitoring		£ 48.00
	ACC-0201	Double slimline unmonitored maglock 12-24 Volt operation 500mm wide x 42mm high x 26mm deep. Current draw 24 Volt 600mA (1.2A @ 12 Volt).	F	£ 80.50
	ACC-0203	As ACC-0201 and with monitoring		£ 91.25
	ACC-0208	L bracket to single slimline maglock.	F	£ 12.25
	ACC-0209	Z & L bracket to suit slimline maglock.	F	£ 22.50
	ACC-0231	High power magnet - 1400lbs holding force, only 156 x 36 x 30mm.	F	£ 137.75
	ACC-0231ZL	Z & L bracket to suit ACC-0231.		£ 30.62
	ACC-0213	Transverse action shoot bolt. Power to lock 12-24vDC 200mm x 32mm (w) x 40mm (d) 16mm throw 900ma (330mA holding).	F	£ 86.00
	ACC-0213a	Transverse action shoot bolt dual voltage 12-24V DC.	F	£ 163.00
	ACC-0214	Housing set to suit transverse action shoot bolt ACC-0213 230 x 45 x 46.	F	£ 49.50
	ACC-0216	Fail safe electric strike.	F	£ 27.55
	ACC-0217	Fail secure electric strike 12v DC.		£ 15.50
	ACC-0218	Electric strike ANSI style short faceplate- user selectable fail safe/secure.	F	£ 61.25
	ACC-0224	Extension lip to suit ACC-0218 25mm		£ 14.35
	ACC-0220	ANSI style electric strike selectable fail safe/secure.	F	£ 66.75
	ACC-0222	Mortice magnet with 300Lbs holding force. Suitable for sliding doors.	F	£ 49.55

Product	ID Number	Description	Ref.	Price
	SEC-0001	Wireless entryphone system, single button external call unit and 3 function rechargeable handset.	F	£ 343.73
	SEC-0014	Wireless entryphone, as SEC-0001 with entry keypad.	F	£ 512.95
	SEC-0002 SEC-0002kp SEC-0002h	Single user audio entry system with robust aluminium 40mm wide caller unit. Audio entry with vandal resistant caller unit & integrated keypad. Spare handset only (max 3 per system)	F	£ 52.00 £ 240.26 £ 18.00
	SEC-0003	RTR Wireless keypad. 22 user codes, up to 6 output signals, Lithium power, IP44. 433.92MHz 144mm H x 80mm W use with SEC-0007 or SEC-0008 receivers.	F	£ 84.50
	SEC-0004	RTR 4 way wireless wall switch, white 433.92MHz. 73mm x 83 mm use with SEC-0007 or SEC-0008 receivers.	F	£ 50.00
	SEC-0005	RTR single channel key fob 433.92MHz use with SEC-0007 or SEC-0008 receivers.	F	£ 31.25
	SEC-0006	RTR 2 channel key fob 433.92MHz use with SEC-007 or SEC-008 receivers.	F	£ 42.00
	SEC-0007	RTR 433.92MHz receiver. 12-24v AC/DC. 1 Form C changeover relay plus 1 Normally open relay, pulse or latch function. Max 85 Tx capacity.	F	£ 70.00
	SEC-0008 SEC-0008a SEC-0008b	RTR 433.92MHz receiver. 230Volt AC. 1 Form C changeover relay 500W switching, IP65, pulse or latch function. Max 6 Tx capacity. 2 channel version 4 channel version	F	£ 69.00 £ 88.25 £ 92.00
	SEC-0009	RTR ACT5 keypad. IP67 rated keypad. 12-24volt AC/DC operation. 10 user codes. 102mm W x 110mm H	F	£ 99.00
	ACC-1657	Reed switch with changeover contact and magnet. Screw fixing. 4M flex for easy connection.	F	£ 9.45
	ACC-1658	Reed switch with changeover contacts. 2m lead with surface and flush mount accessories	F	£ 10.50

Product	ID Number	Description	Ref.	Price
	SEC0010	RTR CT1000 stand alone slimline keypad 12-24 Volt DC operation. 24 user codes, 500mA load switching, IP67. 130mm (h) x 50mm (w) x 10mm (d). With bell output.	H	£ 73.75
	SEC0011	RTR PT1000 stand alone slimline prox reader, 1024 user, on site enrolling mastertag and usertag. Delete all tags, master tags, one tag, missed tags etc. 12Volt DC IP67. 130mm (h) x 50mm (w) x 10mm (d).	H	£ 90.75
	SEC0011E	RTR PT Slimline proximity sensor E Marine - As SEC0011 but uses E Marine style proximity cards.	H	£ 90.75
	SEC0012	RTR proximity tags.	H	£ 5.95
	SEC0012E	RTR Proximity cards.	H	£ 3.75
	SEC0011 KIT230	RTR Slimline proximity sensor. Includes mounting plate, 10 tags and 12V 0.5A PSU.	H	£ 167.00
	SEC0011 KIT24	RTR Slimline proximity sensor. Includes mounting plate, 10 tags, volt reducer with relay output.	H	£ 167.00
	SEC0011E KIT230	RTR Slimline proximity sensor. Includes mounting plate, 10 cards and 12V 0.5A PSU.	H	£ 157.00
	SEC0011E KIT24	RTR Slimline proximity sensor. Includes mounting plate, 10 cards, volt reducer with relay output.	H	£ 157.00
	SEC0015	Mount plate for RTR CT Slimline keypad.	H	£ 21.75
	SEC0016	Surface frame for RTR CT Slimline keypad.	H	£ 15.50
	SEC0023	RTR Fingerprint reader stand alone relay output. Uses high quality thermal sensor. Fully potted IP67 waterproof.	H	£ 297.50
	SEC0023off	RTR Fingerprint reader with PC connection and management software. Maximum 1000 users. Fully potted reader head IP67 waterproof. Complete with PC interface and software	H	£ 575.00
	SEC0030	Combined keypad and proximity reader. Up to 190 users with 2 outputs. Entry by code, tag or both	H	£ 148.75

Product	ID Number	Description	Ref.	Price
	SEC-0036	Mono video entry system with night illumination. External caller unit only 58mm wide		£ 135.00
	SEC-0037	Colour video entry system with night illumination. External caller unit only 58mm wide		£ 327.50
	SEC-0038	Mono video entry system with night illumination. External caller with keypad in robust stainless is only 100mm wide.		£ 307.00
	SEC-0039	Colour video entry system with night illumination. External caller with keypad in robust stainless is only 100mm wide.		£ 495.00
	SEC-0055	SOLO. Cashless payment and entry system. Very flexible IP67 reader heads requiring no network cabling. Can be used to integrate access control and payment systems where cash would not be desirable such as camp sites and schools. Full details on request.		P.O.A.
	ECO-5500	I open gate controller. Easy programming of unit by text message. Unit responds to any authorised number and activates output with no call costs.		£ 165.00
	SEC-0090	Leaver handle set in brushed aluminium with electronic keypad. Up to 10 users with 1-10 digit pin codes. Duress lock out function. <5000 operations on the internal battery.		£ 165.00
	SEC-0092	As above with finger reader		£ 165.00

1. Definition

The term "The Seller" means RTR Services LTD. The term "The Buyer" means the party to whom this document is addressed and these definitions shall apply whether the transaction is for the supply of goods or for the provision of services or for both the supply of goods and the provision of services.

2. Reports and Recommendations

The Seller accepts no liability in respect of any report, recommendation or scheme submitted to the Buyer where no specific charge is made for such report, recommendation or scheme. Where such a charge is made, the Seller's liability shall be limited as hereinafter provided.

3. Prices

Prices quoted are based on costs ruling at the date of the contract and any variation in the cost of materials, labour and service shall be for the Buyer's account if and to the extent that such variation occurs between the date of the contract and the date or dates when the materials, labour or services are supplied, employed or provided. The Seller is entitled to charge for any additional costs caused by any variation in the original contract or for any costs caused by the Buyer's failure to give required instructions or to accept materials or services when they are due to delivery or performance.

4. Delivery

- (a) Carriage will be charged at cost using the most suitable method of delivery available.
- (b) The Seller accepts no liability for any loss or damage resulting from delay in supplying goods or services or for their non-supply, and any dates agreed for delivery or performance shall be regarded as estimated only.
- (c) Non-delivery of materials must be reported within 10 days of consignment/invoice date to allow for recovery. Failure to comply may leave this responsibility with the Buyer.

5. Force Majeur

If the supply of goods or materials or the provision of services is delayed or prevented by reason of industrial action, breakage of machinery, Act of God or by any other reason whatsoever outside the reasonable control of the Seller, the period for completion of the contract shall be extended to such extent as is reasonable having regard to the circumstances.

6. Access

Where the Seller is required to perform work on or deliver goods to the Buyer's premises or premises specified by the Buyer, the Seller shall be given uninterrupted access and reasonable facilities during normal working hours for performance of the contract and the Buyer shall accept delivery of, unload, provide suitable protection for and keep secure all materials and goods delivered from time to time.

7. Risk and Property

- (a) Risk in the goods shall pass to the Buyer on delivery.
- (b) Notwithstanding the above, property in the goods shall remain in the Seller until full payment has been made.
- (c) Payment shall be deemed to be made when cash has been handed to the Seller or the amount of any cheque has been credited to the Seller's bank account and cleared by the Buyer.
- (d) Until such full payment, the Buyer acknowledges that they are in possession of the goods as the Seller's bailee. The Buyer shall store the goods separately from their own goods or those of any other person and in a manner which makes them readily identifiable as the Seller's goods and shall endorse a memorandum on the Buyer's accounts referring to the Seller's title in the goods.
- (e) If payment is overdue the Seller may (without prejudice to any of their other rights) recover and/or resell the goods and the Buyer hereby irrevocably licences their Seller or their agents to enter upon any premises where they are stored or where they are reasonably thought to be stored for the purpose of such recovery and/or resale.
- (f) Payment shall become due immediately upon the commencement of any act or proceedings in which the Buyer's solvency is involved.
- (g) In the event of the Buyer purporting to sell the goods to a third party before payment has been made to the Seller any such proceeds of sale shall be received and held by the Buyer as the Seller's agent. The Buyer therefore acknowledges and agrees to stand in a fiduciary relationship to the Seller and must strictly account to the Seller the proceeds thereof.

8. Plant

Any plant or equipment provided by the Seller in relation to the performance of the Seller's obligations hereunder is provided exclusively for the use of the Seller or its agents and employees and any other person using such plant or equipment does so at the Buyer's risk. The Buyer indemnifies the Seller against any claim made against the Seller in respect of the use of such plant or equipment other than as aforesaid.

9. Liability

- (a) Every sale or contract of sale shall be deemed to include the implied undertakings as to title referred to in Section 12 of the Sale of Goods Act 1979.
- (b) Where the Buyer deals as a consumer within the meaning of Section 12 of the Unfair Contract Terms Act 1977 the provisions of Section 13, 14 and 15 of the Sale of Goods Act 1979 shall apply to this contract but not otherwise.
- (c) Unless expressly so stated in writing by the Seller goods are not sold or tested as conforming to any British Standard Specification nor, save as herein before provided, as fit for any particular purpose and any other term condition or warranty that the goods are so fit is excluded.
- (d) The Buyer does not rely on the Seller's skill or judgement with regard to the goods. No person has authority to make any representation on the Seller's behalf which is not made or confirmed in writing unless so confirmed.
- (e) Save where the Buyer deals as a consumer (as herein defined), the Seller shall only be liable for loss or damage howsoever arising if caused by circumstances within its reasonable control and if a claim is made by the Buyer in writing within 12 months

from the date of supply of the goods or services complained of, and (where the claim relates to the supply of goods or materials) if the goods or materials complained of are returned to the Buyer carriage paid within such period. The Seller's liability whether in contract tort or otherwise arising out of or in connection with this contract or the goods or services supplied or to be supplied shall in any event be limited to an obligation to repair, replace or refund the cost of the defective goods or, at the Seller's option, to a sum equal to the contract price.

- (f) The Company shall be under no liability under the above if the total price for the Goods has not been paid by the due date for payment

10. Preservation of Statutory Rights

Nothing in these conditions shall affect any statutory rights of a consumer where the contract relates to a consumer sale as defined by paragraph 11 of Schedule of the Sale of Goods Act 1979.

11. Contract Conditions

All business transacted shall be deemed to be on the terms of these Conditions and no person has any authority to accept any further liability or to make any amendment on the Seller's behalf. In the event of any conflict between these Conditions and any terms or conditions put forward by the Buyer, these Conditions shall prevail.

12. Payment

- (a) Payment of accounts is to be nett 30 days after the date of the Seller's invoice.
- (b) If the Buyer fails to make due payment of any money owed by it to the Seller on whatever account, the Seller may withhold delivery of all or any part of any goods or materials sold to the Buyer or performance of any services to be rendered to the Buyer until payment in full of all money then due, and during such time any goods so withheld shall be at the sole risk of the Buyer. Interest at the rate of 2% per annum over the base rate of Bank of England for the lending of sterling funds in London as varied from time to time shall be payable on all overdue accounts. The Seller shall not be obliged to deliver or transfer any goods or materials or perform any services subsequent to the contract date if the Seller learns of circumstances which are in the reasonable judgement of the Seller likely adversely to affect the ability of the Buyer to pay for such goods or services in accordance with the contract.

13. V A T

Unless expressly stated otherwise, prices do not include any Value Added Tax which may be chargeable and any such tax must be added to the price where applicable.

14. Arbitration

Should any dispute and/or claim arise between the parties hereto out of or in connection with this contract which cannot be settled amicably, the same shall be referred to arbitration in accordance with the Arbitration Act 1950 and/or any statutory modification thereof or substitution therefore.

15. Governing Law

The contract including these Conditions shall be governed by and construed in accordance with English law.

16. Minimum Charge

All orders will be subject to a minimum charge of £30.

17. Unwanted Goods

Goods may be accepted for return at the discretion of the Seller and will be subject to the handling charge ruling at that time.

Carriage options

UK Mainland only. Up to 20Kg, excluding barriers.

Standard next day before 4pm	£ 9.45
Next day before Noon	£ 15.00
Next day before 10.00	£ 20.00
Next day before 09.00	£ 25.00
Extra charge for additional Kg on any choice	£ 0.32



RTR Services Limited, Unit 14b Wakes Hall Business Centre, Colchester Road, Wakes Colne, Essex CO6 2DY
Tel: +44 (0) 870 242 6029 Fax: +44 (0) 870 242 6030 sales@rtrservices.co.uk www.rtrservices.co.uk